

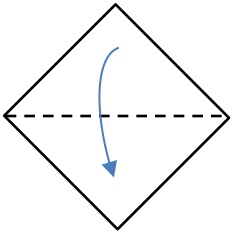

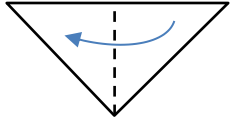
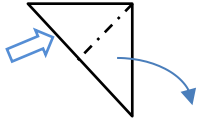
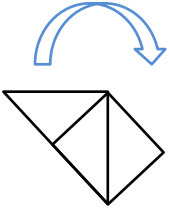
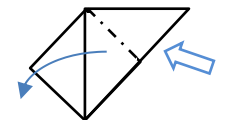
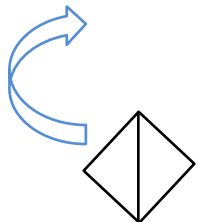
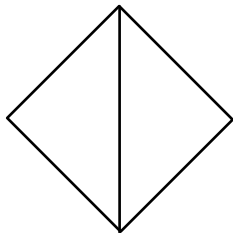
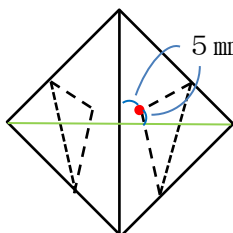
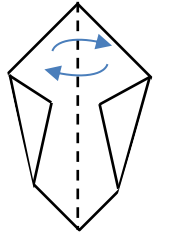
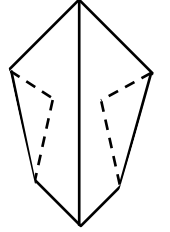
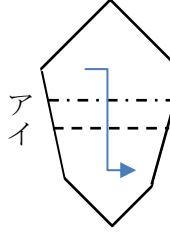
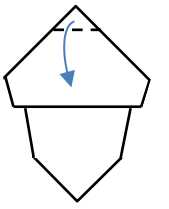
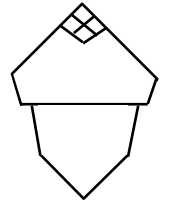

☆折り紙でおがっきを作ろう！☆

【 ぼうしと顔 】			
① 半分に折る 	② 半分に折る 	③ 広げながらつぶすように折る 	④ 折ったところ裏返す 
⑤ 広げながらつぶすように折る 	⑥ 折ったところ上下を返す 	⑦ 拡大 	⑧ 手前と奥それぞれななめに折る 
⑨ 手前と奥を片方だけ折り⑧の折り目を内にする 	⑩ 折ったところ 	⑪ ア 山折り イ 谷折り 	⑫ 下に折り広げ左右の部分をつぶし広げる 
⑬ 緑の柿のへたを貼り付ける 	⑭ 顔を貼り付ける 	⑮ ぼうしのラインを貼り付ける 	⑯ さつきを貼る 

【 着物 】			
① 半分に折り元に戻す 	② ア 谷折り (1/4) イ 山折り (1/12) 	③ 半分に折る 	④ 折ったところ 
⑤ 拡大 点線でななめに折る 	⑥ 点線で折り戻す 	⑦ 折ったところ 	⑧ 一度戻し最初の折り目を半分まで切る 
⑨ 点線にてそれぞれ内側に折り⑧で切った部分も内側に折り入れる 	⑩ 折ったところ 	⑪ 襟・帯のラインを貼り付ける 	

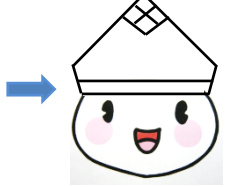
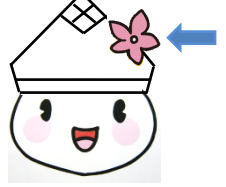
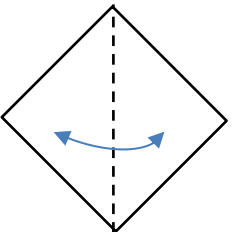
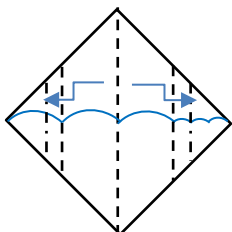
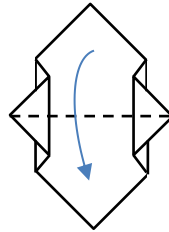
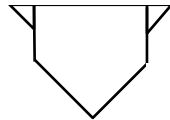
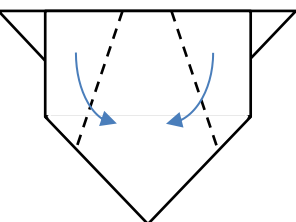
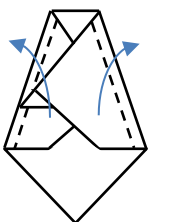
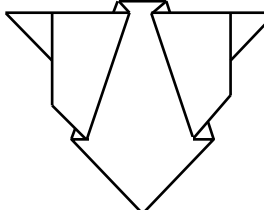
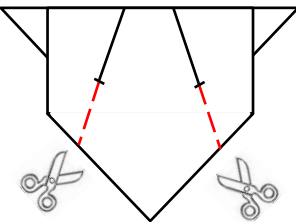
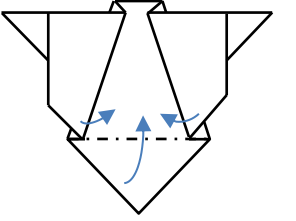
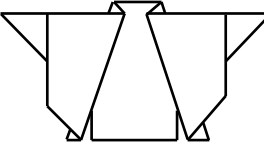
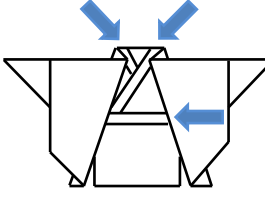
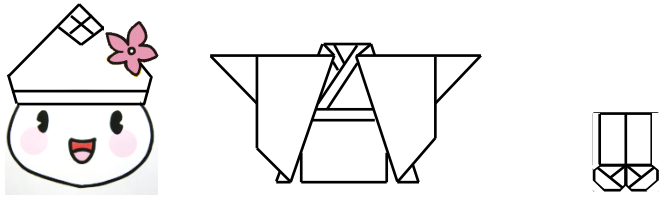
【 組み合わせる 】	
	

考案者：清水恵美子（NPO法人大垣市レクリエーション協会 相談役）
協力：北村小百合